







PLEASE MARK DESIRED LOCATION OF OPTIONS
 SHOWN IN LEGEND ON FLOOR PLAN
 HDW 122010

<u>DESCRIPTION</u>	<u>SYMBOL</u>	<u>DESIGNATION</u>
208V OUTLET =		= Φ
TYP. EMERGENCY FLOOD LIGHTS =		= E/L
120V DUPLEX OUTLET =		= Φ
LIGHT SWITCH =		= \$
MAIN PANEL =		= PNL
TYP. 2' X 4' LAY IN 4 TUBE CLEANROOM LIGHT FIXTURE =		= L/F
TYP. 2' X 4' FAN POWERED HEPA FILTER =		= F/U





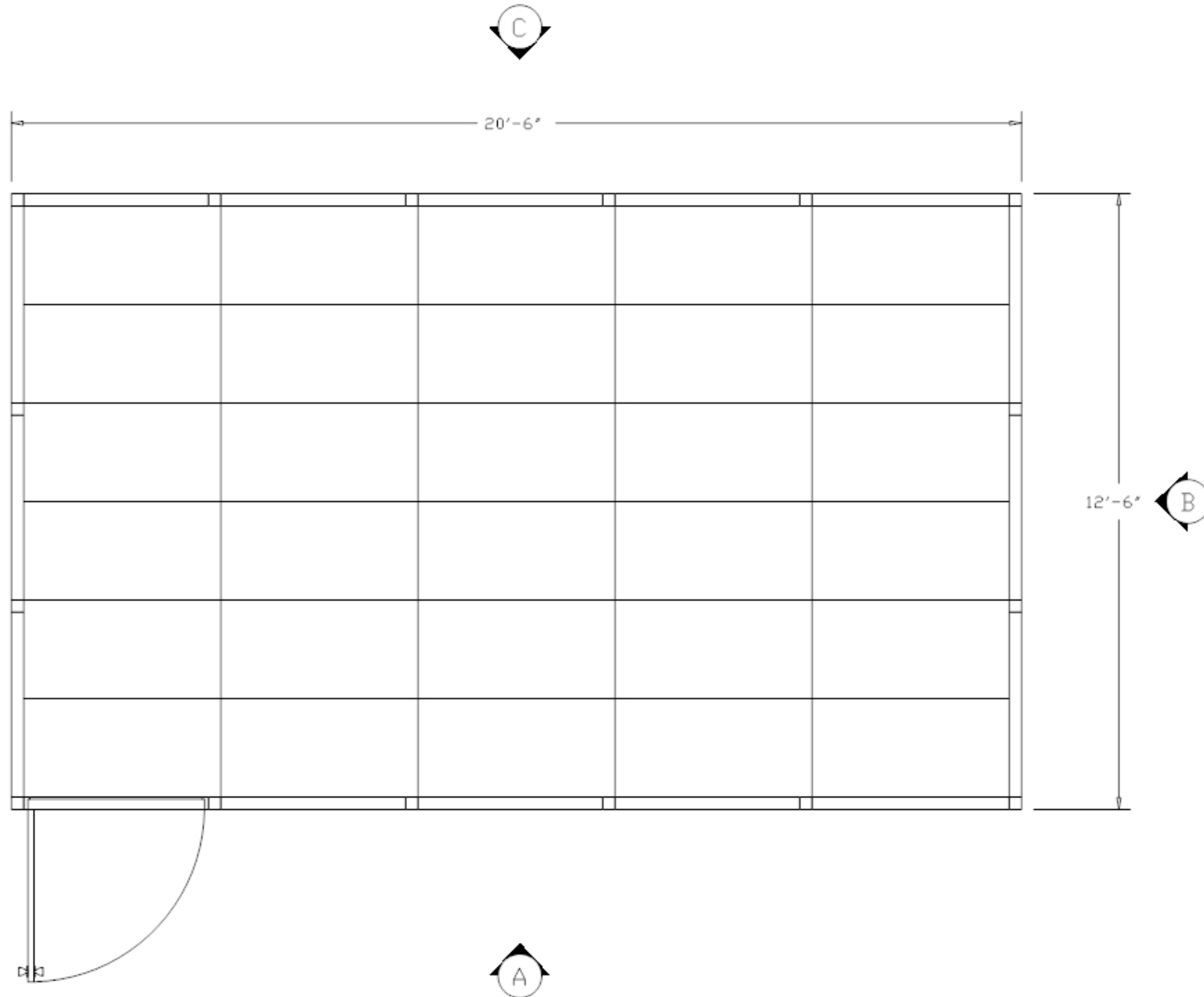
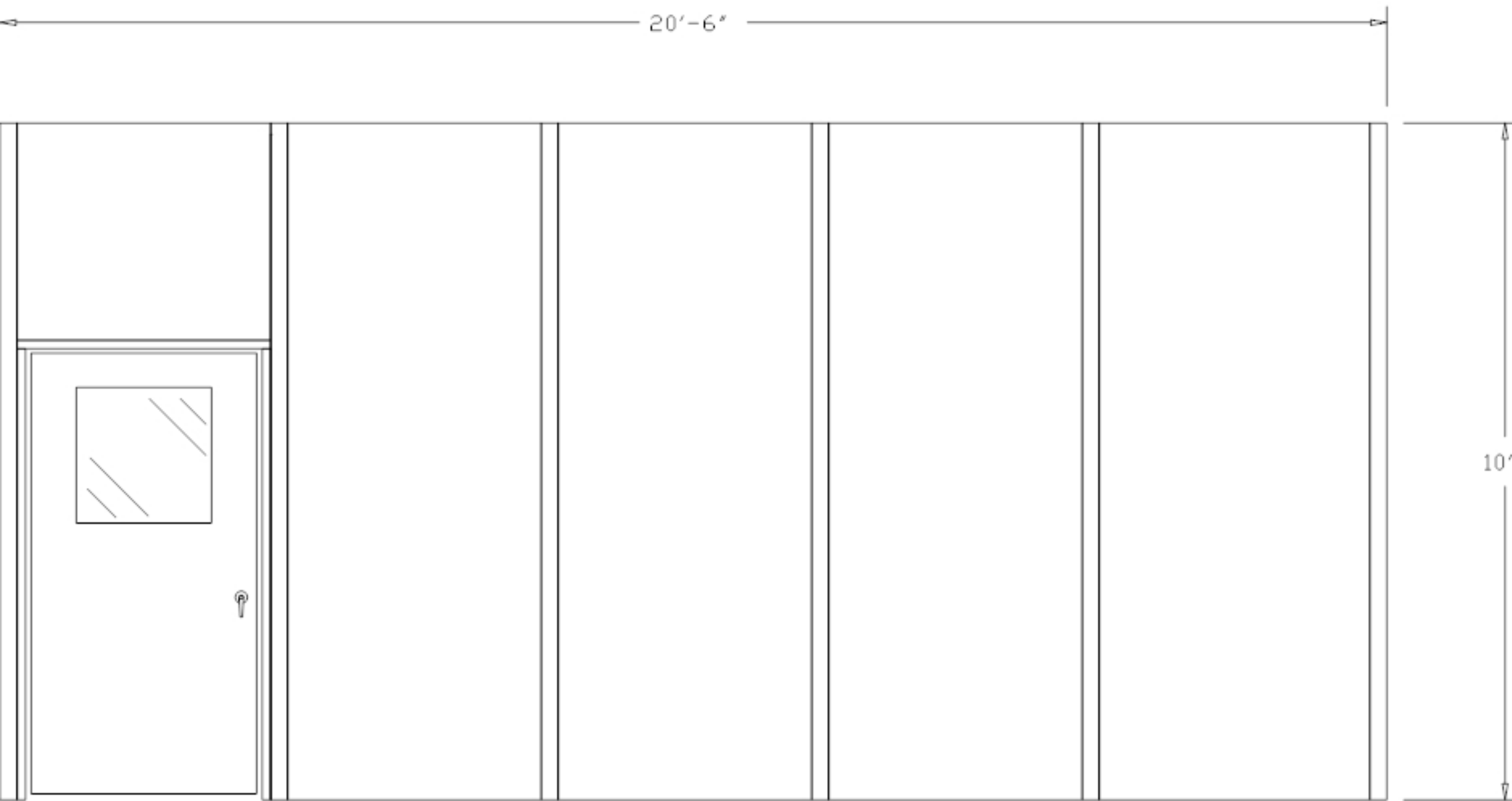

"A" ELEVATION

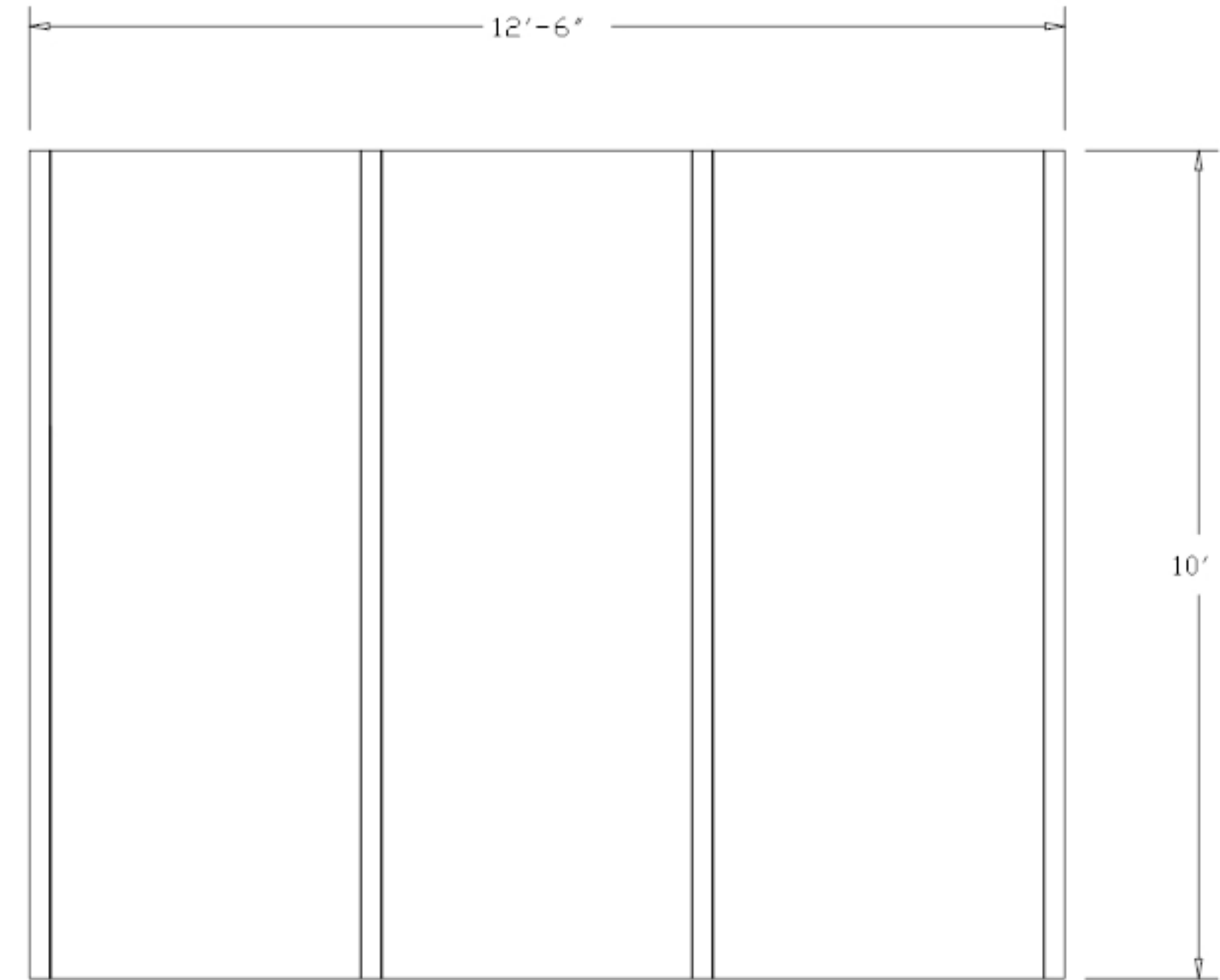
HDW 122010



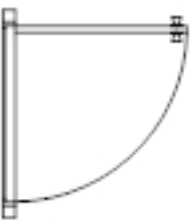
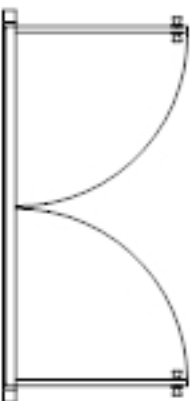

"B" ELEVATION

PLEASE MARK DESIRED LOCATION OF OPTIONS
 SHOWN IN LEGEND ON FLOOR PLAN
 HDW 122010

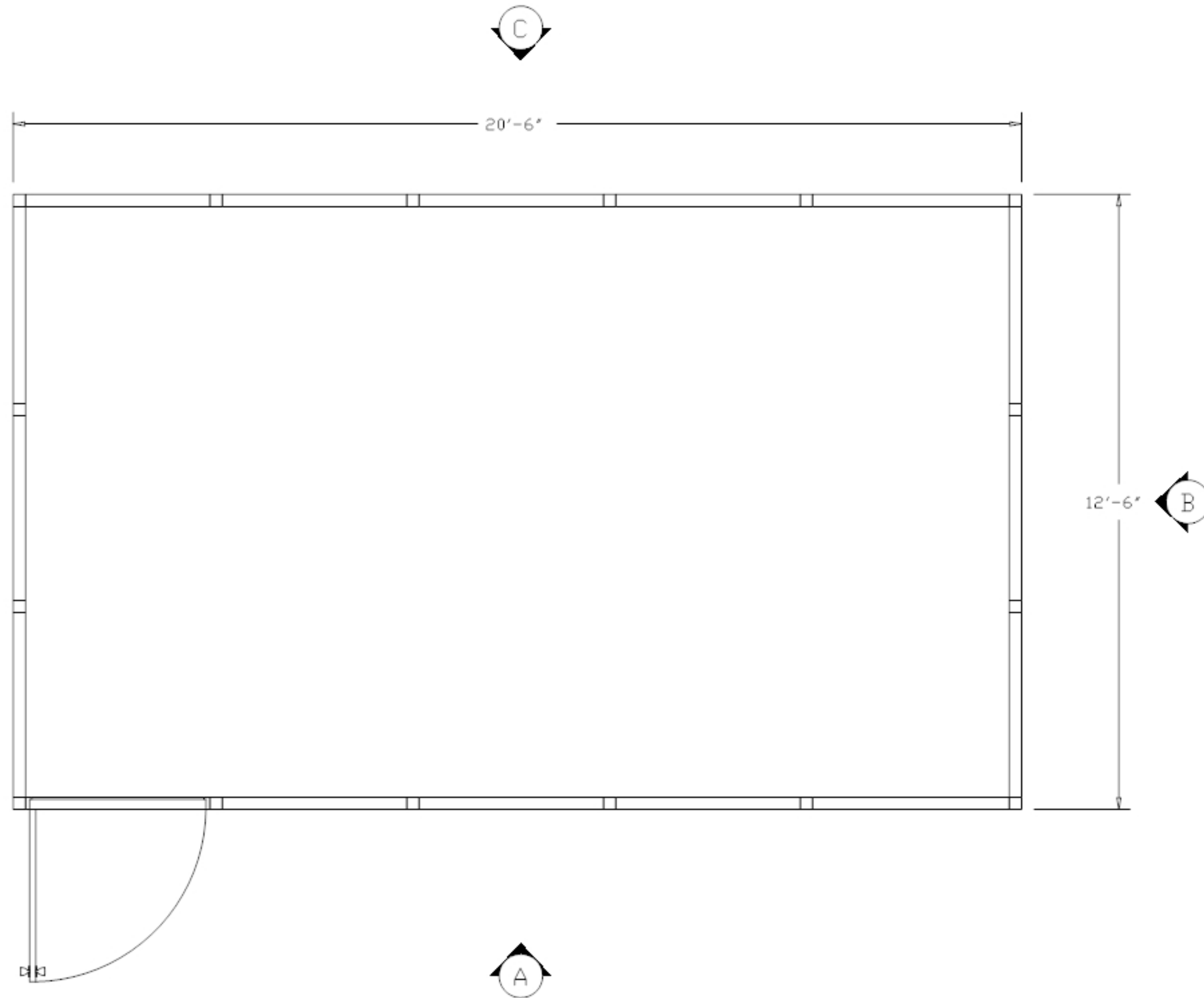
<u>DESCRIPTION</u>	<u>SYMBOL</u>	<u>DESIGNATION</u>
WINDOW PANEL		W/P
SOLID PANEL		S/P
42" X 80" DOOR W/ 2' X 2' WINDOW		D/L
DOUBLE DOOR W/ 2' X 2' WINDOW		DD/L



PLEASE MARK DESIRED LOCATION OF OPTIONS
 SHOWN IN LEGEND ON FLOOR PLAN
 HDW 122010

<u>DESCRIPTION</u>	<u>SYMBOL</u>	<u>DESIGNATION</u>
TYP. 2' X 4' LAY IN CEILING TILE		C/T
TYP. 2' X 4' LAY IN 4 TUBE CLEANROOM LIGHT FIXTURE		L/F
TYP. 2' X 4' FAN POWERED HEPA FILTER		F/U

