









PLEASE MARK DESIRED LOCATION OF OPTIONS  
 SHOWN IN LEGEND ON FLOOR PLAN  
 HDW 8810

<u>DESCRIPTION</u>	<u>SYMBOL</u>	<u>DESIGNATION</u>
208V OUTLET =		
TYP. EMERGENCY FLOOD LIGHTS =		E/L
120V DUPLEX OUTLET =		
LIGHT SWITCH =	\$	\$
MAIN PANEL =		
TYP. 2' X 4' LAY IN 4 TUBE CLEANROOM LIGHT FIXTURE =		L/F
TYP. 2' X 4' FAN POWERED HEPA FILTER =		F/U

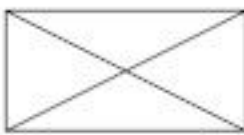

8'-6"

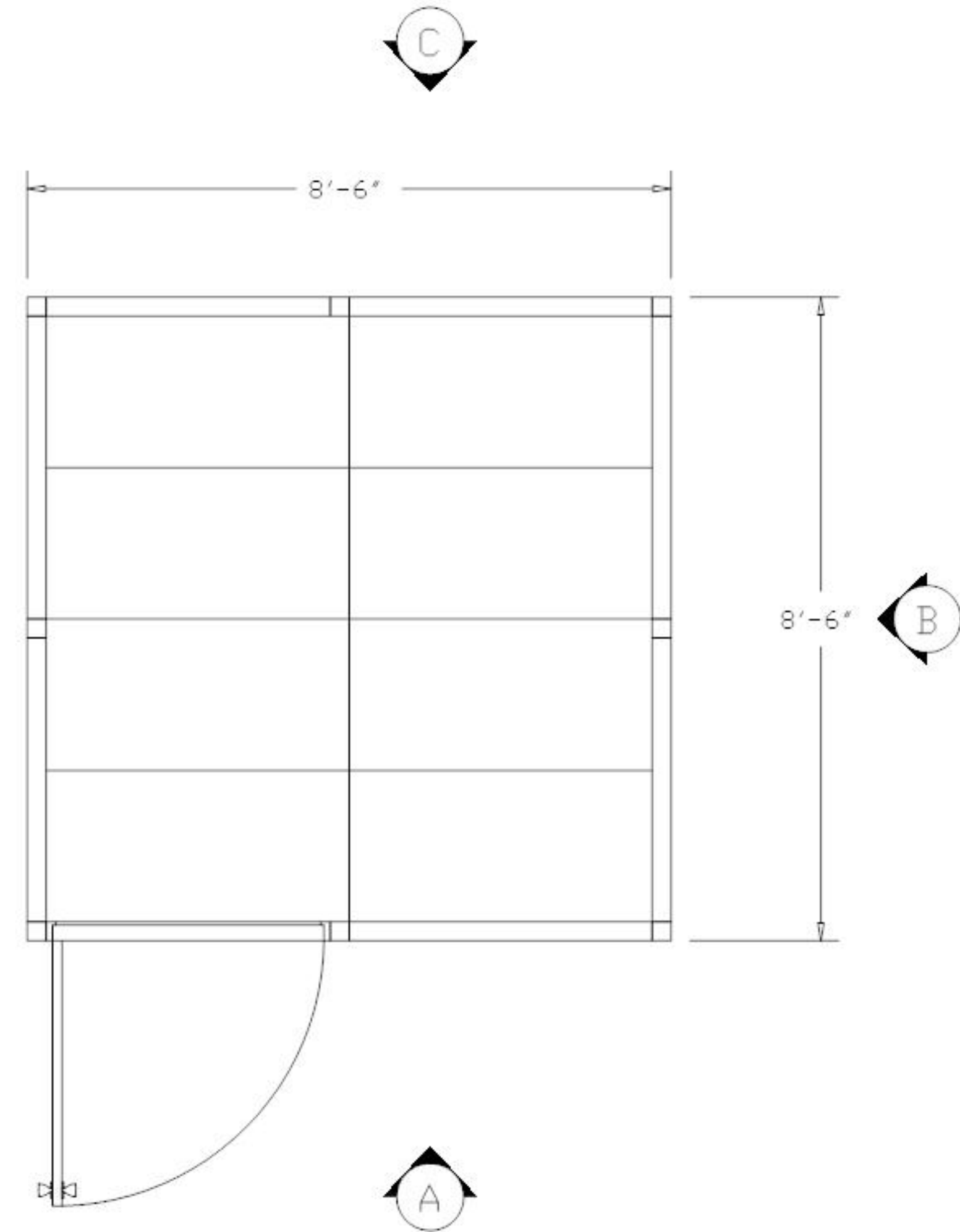
8'-6"

10'

10'

"A" ELEVATION

HDW 8810

"B" ELEVATION

PLEASE MARK DESIRED LOCATION OF OPTIONS  
 SHOWN IN LEGEND ON FLOOR PLAN  
 HDW 8810

DESCRIPTION                      SYMBOL                      DESIGNATION

WINDOW PANEL      =            =      W/P



SOLID PANEL      =            =      S/P

42" X 80" DOOR  
 W/ 2' X 2'  
 WINDOW      =            =      D/L

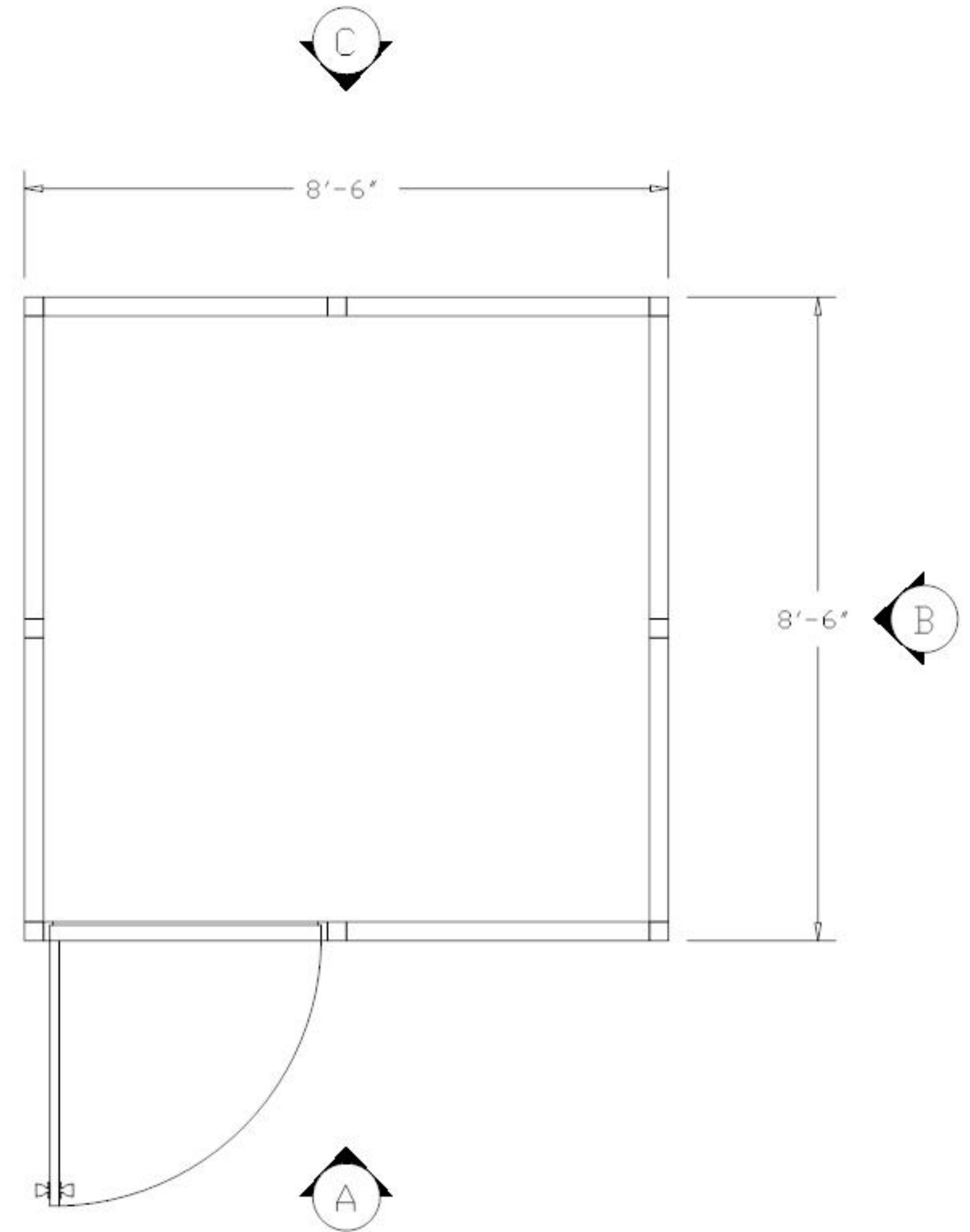
DOUBLE DOOR  
 W/ 2' X 2'  
 WINDOW      =            =      DD/L



PLEASE MARK DESIRED LOCATION OF OPTIONS  
 SHOWN IN LEGEND ON FLOOR PLAN  
 HDW 8810

<u>DESCRIPTION</u>	<u>SYMBOL</u>	<u>DESIGNATION</u>
TYP. 2' X 4' LAY IN CEILING TILE		C/T
TYP. 2' X 4' LAY IN 4 TUBE CLEANROOM LIGHT FIXTURE		L/F
TYP. 2' X 4' FAN POWERED HEPA FILTER		F/U

